

COMMUNICATIONS RECEIVER

R209/2/B

EQUIPMENT MANUAL

Technical Publications Department

EQUIPMENT DIVISION, MULLARD LIMITED
MULLARD HOUSE, TORRINGTON PLACE
LONDON W.C.1. LANGHAM 6633

EM182B-10-56-800

Contents

Chapter 1	Introduction	
	Brief Description	Page 1
	Technical Summary	Page 3
Chapter 2	Circuit Description	
	Receiver	Page 6
	Power Supply Unit	Page 10
Chapter 3	Installation and Setting-Up	Page 14
Chapter 4	Operation	Page 17
	Parts List	Page 18

Illustrations

Figure 1	Receiver Type R209/2/B	Page 2
Figure 2	Internal View of Receiver	Page 5
Figure 3	Selector Switch, Pawl and Fuseholder	Page 7
Figure 4	Connections to Input Sockets	Page 9
Figure 5	Circuit Diagram	Page 12
Figure 6	Spare Parts Case	Page 16

CHAPTER 1

INTRODUCTION

BRIEF DESCRIPTION

This receiver, an improved version of the original R209, is a general-purpose receiver suitable for use as a manpack or in vehicle and fixed stations. Its solid construction renders it waterproof and almost completely air-tight. For further protection, a silica gel desiccator is provided to absorb any moisture remaining in the receiver which occurs through normal breathing, thus making it suitable for operation in extremes of climate. The R209 is built on sturdy lines, enabling it to withstand considerable shock and rough usage, and having been designed to meet the K114 specification.

The receiver is simple to operate and may be used with the built-in loudspeaker and with one or two pairs of 150 ohm headphones. A cover is provided to protect the loudspeaker against the ingress of moisture; this may also be used to mute it when not required.

Facilities are provided for c.w. and m.c.w. telegraphy and a.m. and f.m. telephony reception by rod, open wire or dipole aerials.

The receiver will operate from a 12V or 24V battery supply or from an a.c. mains supply of 115V or 220V, 50-60 c/s. It is possible in certain circumstances to substitute alternative tapplings for a.c. mains operation. Two supply leads are provided as accessories, one for battery and the other for a.c. mains operation. The voltage selector switch has four positions corresponding to the voltages stated, the knob being locked in position when the set is being operated.

Precautions are taken so that damage cannot occur if d.c. is applied when the selector switch is set to 115V or 220V, or if a.c. is applied with the selector switch at 12V or 24V.

The receiver consists of nine separate units of which four are mounted on the front panel casting, the remainder being of the plug-in type. The fixed units are:—

- R.f. unit.
- I.f. chassis.
- A.f. unit.
- Power supply unit.

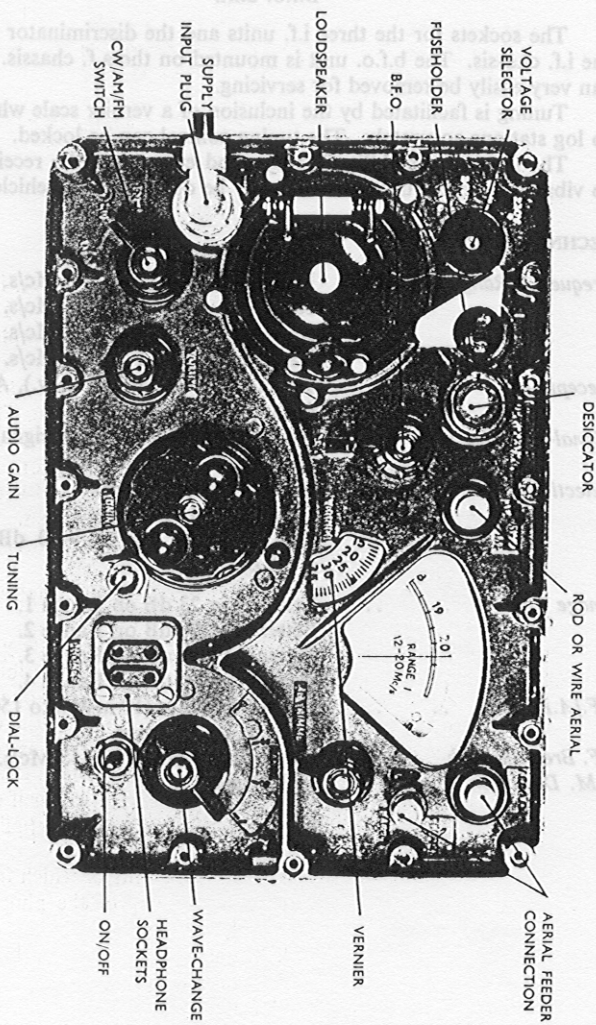

Figure 1 Receiver Type R209/2/B

The plug-in units are:—

3 similar i.f. units.
Discriminator unit.
B.f.o. unit.

The sockets for the three i.f. units and the discriminator unit are part of the i.f. chassis. The b.f.o. unit is mounted on the a.f. chassis. All these units can very easily be removed for servicing.

Tuning is facilitated by the inclusion of a vernier scale which can be used to log stations accurately. The tuning control can be locked.

The frequency stability is very good even when the receiver is subjected to vibration; consequently the set may be operated in a vehicle on the move.

TECHNICAL SUMMARY

<i>Frequency Range</i>	Range 1 .. 12.0–20.0 Mc/s. Range 2 .. 5.5–12.5 Mc/s. Range 3 .. 2.3– 5.6 Mc/s. Range 4 .. 1.0– 2.3 Mc/s.
<i>Reception</i>	Types of reception: A1 (c.w.), A2 (m.c.w.), A3 (a.m.), and F3 (f.m.).
<i>Signal-to-Noise Ratio</i> ..	At least 20 dB with 5 μ V signal applied to the 80 Ω input.
<i>Selectivity</i>	4–6 kc/s at 6 dB down. 13 kc/s at 40 dB down. Cut off slope –6 to –40 dB not less than 9 dB per kc/s.
<i>Image Ratio</i>	Better than 23 dB on Range 1. Better than 28 dB on Range 2. Better than 40 dB on Range 3. Better than 50 dB on Range 4.
<i>I.F./A.F. Gain</i>	Standard output (10 mW into 150 Ω) for 60 μ V input to 1st i.f. stage.
<i>I.F. Breakthrough</i>	Better than 70 dB at 1.045 Mc/s.
<i>F.M. Deviation</i>	\pm 3.5 kc/s.

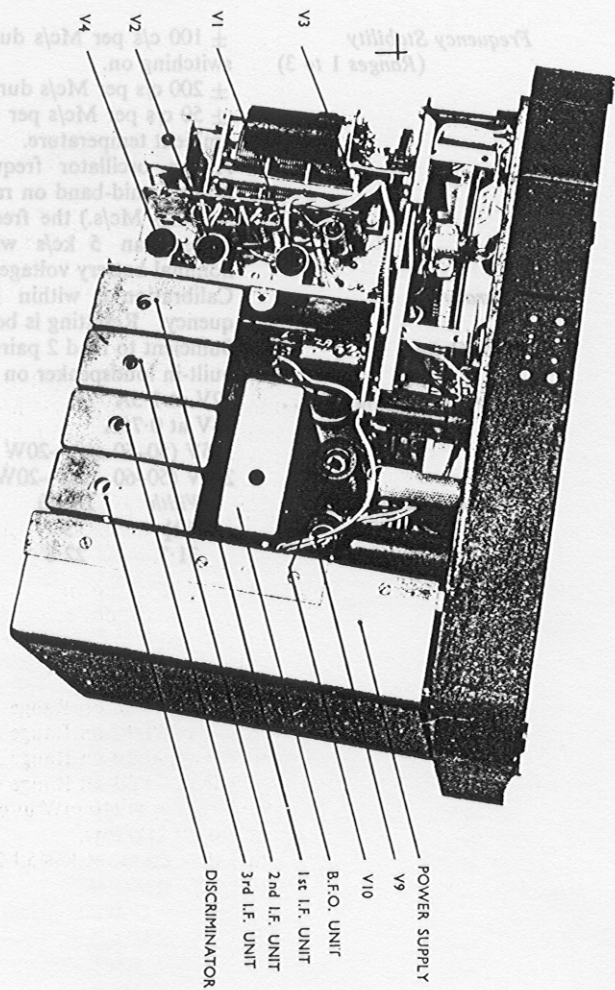

Figure 2

Chassis with Plug-in Units

Frequency Stability
(Ranges 1 to 3)

± 100 c/s per Mc/s during initial 30 min from switching on.

± 200 c/s per Mc/s during 60 min.

± 50 c/s per Mc/s per degree centigrade rise in ambient temperature.

At an oscillator frequency of 16 Mc/s (i.e. approx. mid-band on range 1—signal frequency = 15.54 Mc/s.) the frequency will not change more than 5 kc/s with $\pm 10\%$ change in nominal battery voltage.

Accuracy

Calibration is within $\pm 1\%$ of indicated frequency. Resetting is better than 5 kc/s.

Audio Output

Sufficient to lead 2 pairs of headphones and the built-in loudspeaker on medium signal.

Power Consumption ..

12V at 1.5A

24V at 0.75A

115V (50-60 c/s)—20W

220V (50-60 c/s)—20W

Dimensions and Weight ..

<i>Width</i>	<i>Depth</i>	<i>Height</i>	<i>Weight</i>
12½	9	8½ in	24 lb
31.7	22.8	21.6 cm	10.9 kg

CHAPTER 2

CIRCUIT DESCRIPTION

Receiver

The R209/2/B is a high-grade superheterodyne receiver (fig. 5) using ten valves plus a voltage stabiliser as follows:—

r.f. amplifier	V1 —CV131
mixer	V2 —CV782
neon stabiliser	V3 —CV284
local oscillator	V4 —CV785
1st i.f. amplifier	V5 —CV785
2nd i.f. amplifier	V6 —CV785
3rd i.f. amplifier	V7 —CV785
2nd detector (on a.m. and c.w.)	V8 —CV784
a.f. output	V9 —CV785
a.f. output and a.v.c. delay	V10—CV784
b.f.o...	V11—CV784

Provision is made for low and high impedance aerials by two inputs, at 80 ohms and 1000 ohms respectively. Maximum gain is achieved by arranging for the inputs to be correctly matched to the r.f. tuned circuits by transformer coupling.

The r.f. amplifier V1 is a pentode type CV131. The grid circuits are tuned by a section of the 3-gang main tuning capacitor C94A. A small variable capacitor C19 across the main section is controlled by the knob labelled AE TRIMMER. The latter compensates for different aerial capacitances. The a.g.c. is applied via the resistor R60 decoupled by C75.

The mixer V2 is a pentagrid type CV782. The grid circuits are tuned by the second section of the 3-gang main tuning capacitor C94B. An intermediate frequency of 460 kc/s is developed across the tuned primary of the first i.f. transformer the secondary of which is connected to the grid of the first i.f. amplifier V5.

As an additional precaution against frequency drift with change of current drain and subsequent change in voltage, the screen of the mixer valve is stabilised by V3 a neon type CV284.

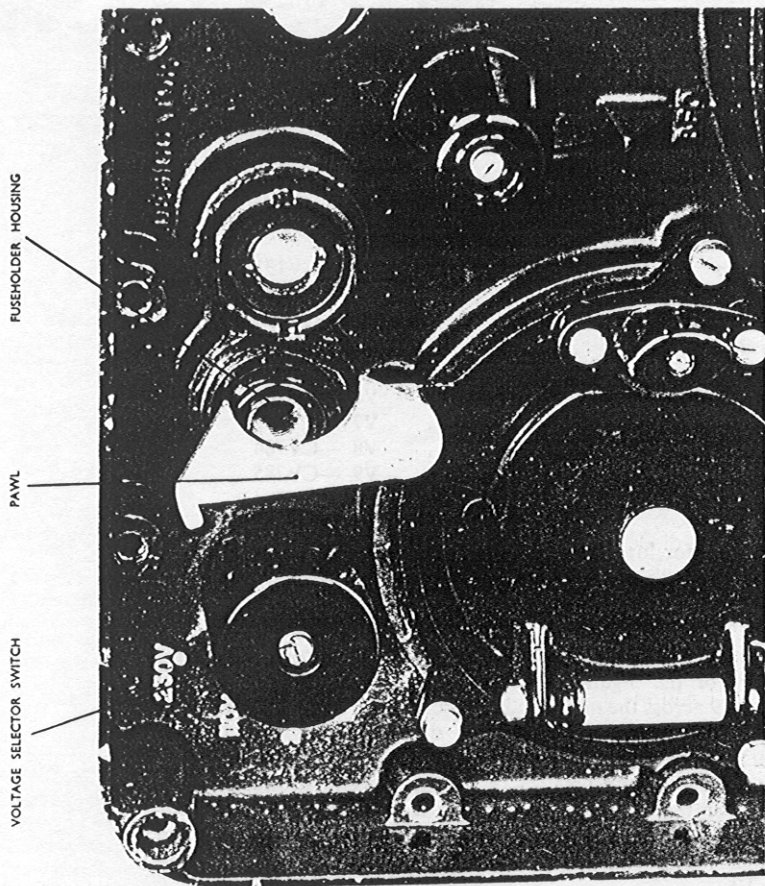

Figure 3 Selector Switch, Pawl and Fuseholder

The local oscillator is a tuned grid reaction oscillator using a pentode V4, type CV785, with screen and anode strapped. The required r.f. voltage for mixing is obtained from the control grid which is connected directly to the grid of the mixer. The h.t. to the local oscillator is also stabilised by means of the neon V3 whose working voltage is approximately 75V.

The i.f. amplifiers V5, V6 and V7 use pentodes type CV785. Each stage is constructed in unit form and is housed in an aluminium can mounted on a plug-in base. The three stages are identical, each i.f. transformer consisting of two pairs of cup type iron dust cores enclosing a coil former. The overall bandwidth is 5 kc/s at -6 dB. A.g.c. is applied to the first two stages only.

The detector is a diode-pentode V8, type CV784. This stage is built as a plug-in unit. The valve acts in the following ways for the different types of reception provided:—

- (a) For A2 and A3 reception, the h.t. is removed from the valve which then acts as a simple diode detector using the control grid and heater. The diode load is the volume control VR1a. Part of the audio voltage is tapped off by the slider of the volume control and is fed to the grid of the first output stage V9.
- (b) On A1 signals the valve is used as above, the b.f.o. V11 output being injected at the control grid. In this case the audio voltage is fed to the grid of the first output valve V9 through a Scott-type negative-feedback filter.
- (c) For F3 reception the h.t. is applied to the pentode section of V8 which is used as an amplifier-limiter and the diode section becomes the discriminator diode. To achieve good f.m. reception, strong signals are necessary.

The b.f.o. employs a diode-pentode V11 type CV784 in a modified Hartley circuit, the whole being housed in a plug-in case similar to those used for the i.f. units. The oscillator is tunable over a range of 1.2 kc/s on each side of the i.f. by the B.F.O. control. The anode is electron coupled to the oscillator section. The oscillator output is fed through C87 to the grid circuit of V8.

On a.m. the a.g.c. is obtained from the detector diode load and is applied to the r.f. amplifier V1 and the first two i.f. amplifiers V5, V6. On c.w. part of the b.f.o. output is rectified by the diode section of V11. A portion of this rectified voltage, depending in magnitude upon the setting of the VOLUME control, is applied through the slider to the grids of V1, V5 and V6, through the a.g.c. line and to the grid of V7.

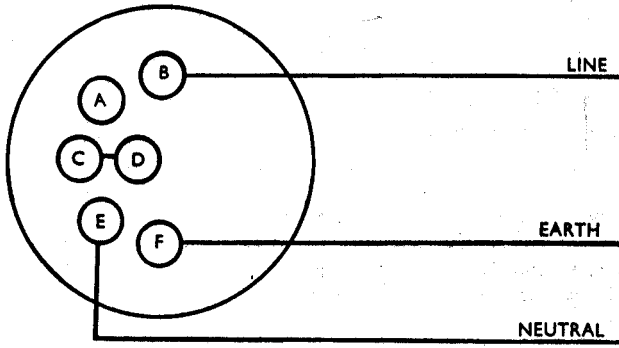

MAINS LEAD

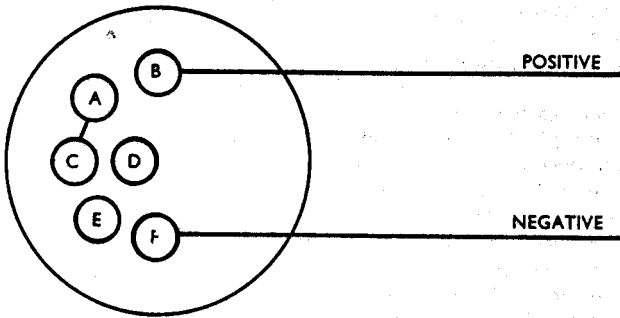

BATTERY LEAD

Figure 4 Connections to Input Sockets

The audio output of approximately 50 mW is obtained from V9 a pentode type CV785 and V10 a diode-pentode type CV784 in a self-drive push-pull circuit feeding a 10 ohm loudspeaker; sockets for 150 ohm headphones are provided.

A Scott-type negative-feedback filter is used in the output stage to peak the beat note on c.w. at an audio frequency of 950 c/s.

Power Supply Unit

The power supply unit delivers approximately 95V d.c. and approximately 6.3V d.c. for h.t. and l.t. supplies respectively. When operated from 12V or 24V d.c., the consumption is approximately 1.5A and 0.75A respectively. On a.c. operation the power consumption is approximately 20W for both the 220V and 115V inputs.

A 12V vibrator is used for both the battery input positions, the resistor R206 being brought into the coil circuit for the 24V input. Extensive r.f. filtering is carried out both in the mains transformer primary circuit and after rectification.

The h.t. supply is obtained from the bridge rectifier W201, followed by a conventional capacitor input filter, L207 C214. The output from this filter feeds the stabiliser V3 via the dropping resistor R205, in addition to supplying all stages except the local oscillator and the screen grids of the mixer, which are supplied from V3.

The l.t. supply is produced by the full-wave rectifier W203. V1 requires the full voltage of 6.3V, but the remaining valves all have 1.4V filaments with separate dropping resistors.

The power input connector on the front panel is a 6-pin plug for which two leads are provided, one for use with a.c. mains, the other being fitted with battery lugs.

A 2-pin plug with earthed side-contacts is attached to the mains lead. The battery lugs are identified by colour as positive and negative; the negative (b' k) lead is connected to the frame of the receiver. The sockets which mate with the panel plug are connected so that no damage can occur if the battery lead is in position with the voltage selector switch set for one of the mains positions, and vice-versa. This will not, however, give any protection if the selector switch is in the wrong *battery* position with the *battery* lead connected or in the wrong *mains* position with the *mains* lead connected.

The voltage selector switch is located in the upper left-hand corner of the front panel (fig. 3) and has four positions, two for battery operation and two

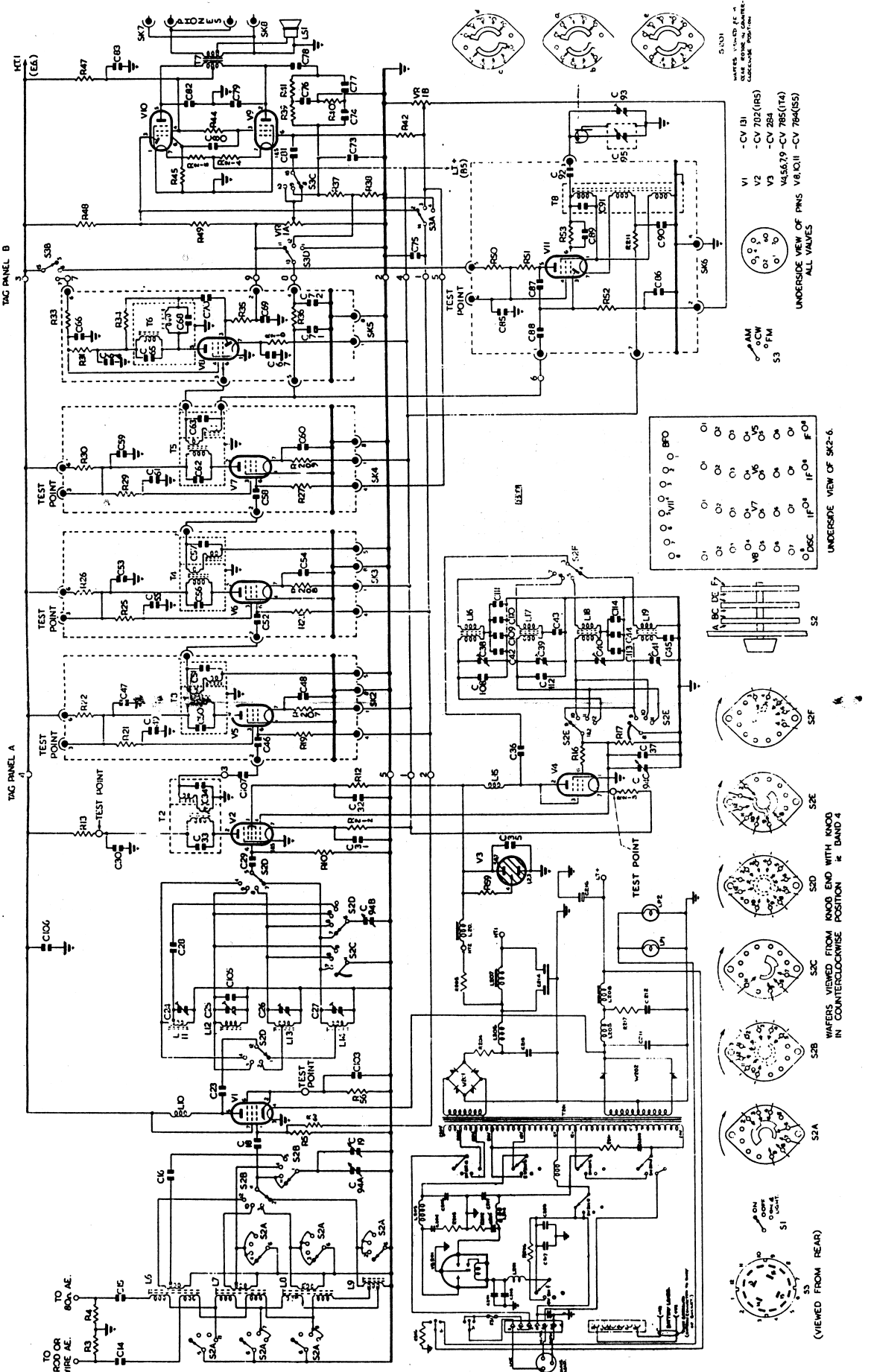

Figure 5 Circuit Diagram

CHAPTER 3

INSTALLATION & SETTING-UP

Before proceeding to operate the receiver, make a general mechanical inspection to see that it is in sound condition and that switches and control knobs work normally.

If installed in a special mounting for use as a manpack, vehicle or ground station, ensure that the receiver is held securely.

Setting Up

- (1) Set the main supply switch to OFF.
- (2) Connect the aerial lead or dipole feeder to the appropriate aerial terminal on the set; the connecting lead from a vertical rod or a single horizontal wire aerial should be connected to the terminal marked AE ROD WIRE and the feeder from a dipole aerial should be connected to the two terminals marked AE 80Ω FEEDER. The lower of the two latter terminals is an earth terminal to which the outer sheath of the feeder should be connected.
- (3) Close the loudspeaker cover. Headphones should always be used when possible.
- (4) Insert phones plug into the PHONES socket.
- (5) Set the b.f.o. knob into the central position, i.e. with the knob pointer opposite the b.f.o. indicator on front panel.
- (6) If the voltage selector switch is not set to the correct position for the available supply then remove the fuse carrier with its fuse and insert it in the space provided for it in the SPARE PARTS CASE. The pawl can now be moved to allow the switch to be set to the correct position. Reset the pawl and insert the appropriate fuse carrier and fuse.

- (7) Attach the appropriate input lead to the set.
- (8) The set should always be earthed by means of the terminal on the side of the case.

For a.c. operation the three-core lead with its two-pin plug and earthed side contacts comply with normal safety requirements.

For battery operation, the lugs are identified as positive (red) and negative (black), the black lead being connected to the chassis of the set. The set is not sensitive to the polarity of the d.c. input, but on installation the black lead should always be connected to the chassis of the vehicle whether a positive or negative earth system is used.

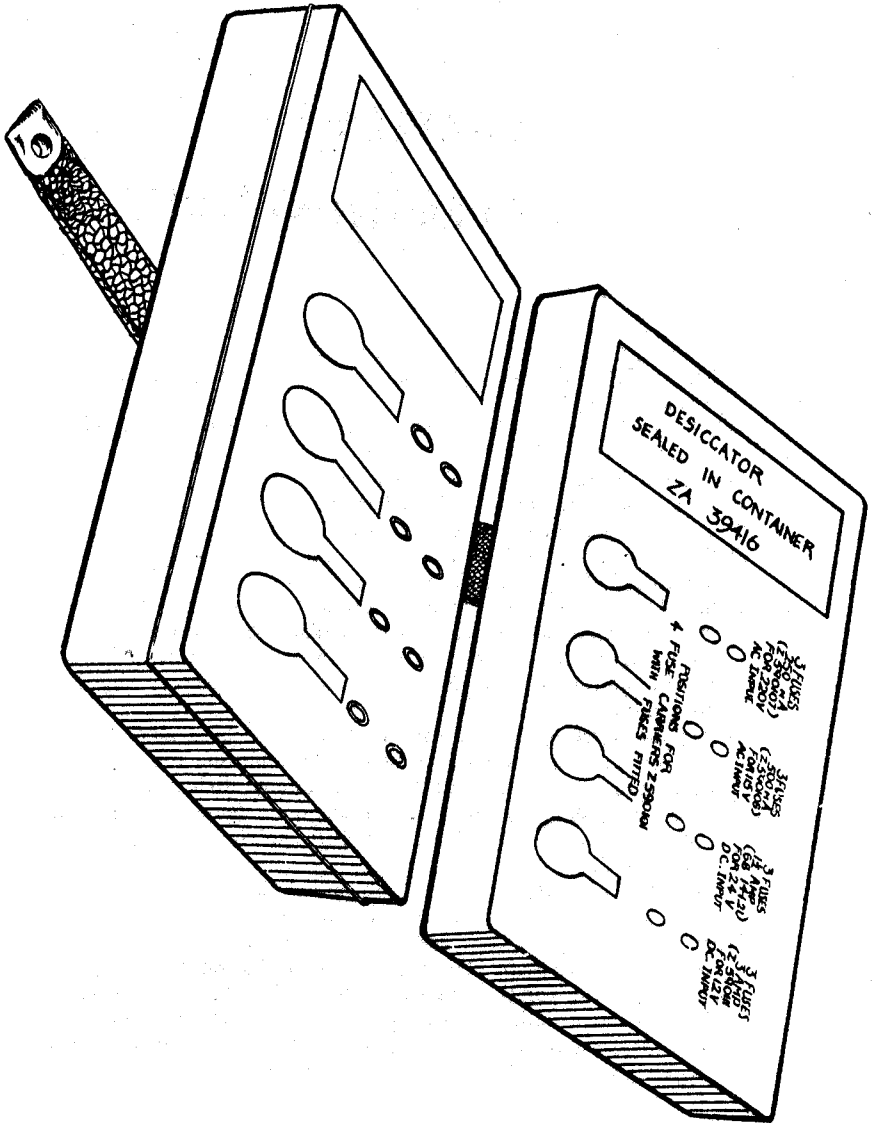

Figure 6 Spare Parts Case

CHAPTER 4

OPERATION

- (1) Set the RANGE switch (S2) to the number covering the required frequency range.
- (2) Set the FM-CW-AM switch (S3) to the required system of operation.
- (3) Switch ON the power supplies at source.
- (4) Switch the set to ON or ON & LIGHT.
- (5) Turn the VOLUME control clockwise.
- (6) Rotate the main TUNING knob until the required dial frequency is immediately below the hairline on the window.
- (7) Search for the required station by turning the TUNING knob slowly in both directions. To ensure that the dial setting for this station is not disturbed, the dial lock may be screwed up (clockwise). Finally, adjust the AE TRIMMER knob for maximum signal-to-noise ratio.
- (8) If a dial resetting log for various stations has been made for the receiver, tune in any required station by adjusting the TUNING knob until the main and VERNIER calibrated dials give the exact resetting readings of the wanted station. Screw up the dial lock. Finally, adjust the AE TRIMMER knob for maximum signal-to-noise ratio.
- (9) Turn the VOLUME control knob anti-clockwise until the signal heard in the headphones is at the required strength.
- (10) When operating on c.w., and after the required station has been located, turn the main TUNING knob until the beat frequency falls to zero (silent point). Screw up the dial lock, then adjust the B.F.O. control until the beat note rises to a convenient pitch; the circuit is designed to give a peak output at 950 c/s. Finally, adjust the AE TRIMMER knob for maximum signal-to-noise ratio.

PARTS LISTS

Circuit Ref.	Value	Description
RESISTORS		
R3	47k Ω	Carbon
R4	47k Ω	"
R5	2.2M Ω	"
R10	2.2M Ω	"
R12	4.7k Ω	"
R13	2.7k Ω	"
R16	150 Ω	"
R17	33k Ω	"
R19	2.2M Ω	"
R21	22k Ω	"
R22	3.3k Ω	"
R23	2.2M Ω	"
R25	22k Ω	"
R26	3.3k Ω	"
R27	2.2M Ω	"
R29	22k Ω	"
R30	3.3k Ω	"
R31	22k Ω	"
R33	10k Ω	"
R34	0.68M Ω	"
R35	0.33M Ω	"
R36	47K Ω	"
R37	0.47M Ω	"
R38	1M Ω	"
R39	2.2M Ω	"
R40	1M Ω	"

Circuit Ref.	Value	Description
R41	2.2M Ω	Carbon
R42	10M Ω	"
R44	22k Ω	"
R45	10k Ω	"
R47	1k Ω	"
R48	2 \times 10M Ω	Carbon (In Series)
R49	2.2M Ω	Carbon
R50	4.7k Ω	"
R51	33k Ω	"
R52	68k Ω	"
R53	33k Ω	"
R56	220 Ω	"
R59	15k Ω	"
R60	2.2M Ω	"
R201	18 Ω	Wirewound
R202	1 Ω	"
R203	1 Ω	"
R204	470 Ω	"
R205	1k Ω	"
R206	40 Ω	"
R207	91 Ω	"
R208	91 Ω	"
R209	91 Ω	"
R210	91 Ω	"
R211	91 Ω	"
R212	91 Ω	"
R213	91 Ω	"
R214	91 Ω	"
R215	91 Ω	"
R216	50 Ω	"
R217	5 Ω	"
VR1A } VR1B }	1M Ω	Carbon Pot'r (ganged)

Circuit Ref.	Value	Description
CAPACITORS		
C14	5000pF	Moulded Mica
C15	0.0082 μ F	Metal Pack
C16	400pF	Silvered Mica
C18	470pF	" "
C19	25pF	Air Trimmer
C23	470pF	Silvered Mica
C24	3-30pF	Air Trimmer
C25	3-30pF	" "
C26	3-30pF	" "
C27	3-30pF	" "
C28	400pF	Silvered Mica
C29	470pF	" "
C30	0.01 μ F	Paper Tubular
C31	0.1 μ F	" "
C32	0.01 μ F	" "
C33	470pF	Silvered Mica
C34	470pF	" "
C35	0.1 μ F	Paper Tubular
C36	470pF	Silvered Mica
C37	10pF	Temperature Compensator
C38	3-30pF	Air Trimmer
C39	3-30pF	" "
C40	3-30pF	Air Trimmer
C41	3-30pF	" "
C42	150pF	Silvered Mica
C43	4000pF	" "
C44	750pF	" "
C45	750pF	" "
C46	200pF	" "
C47	0.01 μ F	Paper Tubular
C48	0.1 μ F	" "
C49	0.01 μ F	" "
C50	470pF	Silvered Mica
C51	470pF	" "
C52	200pF	" "
C53	0.01 μ F	Paper Tubular

Circuit Ref.	Value	Description
C54	0.1 μ F	Paper Tubular
C55	0.01 μ F	" "
C56	470pF	Silvered Mica
C57	470pF	" "
C58	200pF	" "
C59	0.01 μ F	Paper Tubular
C60	0.1 μ F	" "
C61	0.01 μ F	" "
C62	470pF	Silvered Mica
C63	470pF	" "
C64	0.01 μ F	Paper Tubular
C65	100pF	Silvered Mica
C66	0.01 μ F	Paper Tubular
C67	0.1 μ F	" "
C68	100pF	Silvered Mica
C69	47pF	" "
C70	100pF	" "
C71	47pF	Ceramic
C72	100pF	Silvered Mica
C73	100pF	" "
C74	68pF	" "
C75	0.1 μ F	Paper Tubular
C76	150pF	Silvered Mica
C77	68pF	" "
C78	0.01 μ F	Paper Tubular
C79	2000pF	Moulded Mica
C80	0.1 μ F	Paper Tubular
C81	470pF	Silvered Mica
C82	2000pF	Moulded Mica
C83	0.1 μ F	Paper Tubular
C85	0.01 μ F	" "
C86	5000pF	Moulded Mica
C87	470pF	Silvered Mica
C88	15pF	" "
C89	470pF	" "
C90	0.1 μ F	Paper Tubular
C91	470pF	Silvered Mica
C92	68pF	" "

Circuit Ref.	Value	Description
C93	3-30pF	Air Trimmer
C94A } C94B } C94C }	3 × 300pF	Variable 3 Gang
C95	25pF	Air Trimmer
C103	0.1μF	Paper Tubular
C105	10pF	Silvered Mica
C106	0.1μF	Paper Tubular
C107	10pF	Silvered Mica
C108	10pF	Silvered Mica
C109	150pF	" "
C110	10pF	Ceramic
C111	10pF	Temperature Compensator
C112	10pF	Silvered Mica
C113	750pF	" "
C114	100pF	Ceramic
C201	0.5μF	Paper Tubular
C202	0.5μF	" "
C203	0.01μF	" "
C204	0.01μF	" "
C205	0.01μF	" "
C206	0.5μF	" "
C207	0.5μF	" "
C208	1μF	" "
C209	100μF	" "
C210	0.5μF	" "
C211	0.1μF	" "
C212	500μF	" "
C213	0.1μF	" "
C214	30 + 30μF	" "
C216	6000μF	" "
C217	0.01μF	" "
VALVES	Type No.	
V1	CV.131	Pentode
V2	CV.782	"
V3	CV.284	Reference Voltage Tube

Circuit Ref.	Type No.	Description
V4	CV.785	Pentode
V5	CV.785	"
V6	CV.785	"
V7	CV.785	"
V8	CV.784	Diode-Pentode
V9	CV.785	Pentode
V10	CV.784	Diode-Pentode
V11	CV.784	" "
W201		Metal Rectifier
W202		" "

MISCELLANEOUS

Value	Description
T2	1st I.F. Transformer
T3	2nd " "
T4	3rd " "
T5	4th " "
T6	Discriminator Transformer
T7	Output Transformer
T8	B.F.O. Transformer
T201	Main Transformer
L7 } L8 } L9 }	Aerial Coil
L10	H.F. Choke
L11 } L12 } L13 } L14 }	R.F. Coil
L15	H.F. Choke
L16 } L17 } L18 } L19 }	Oscillator Coil
L20	H.T. Smoothing Choke
L201	H.F. Choke
L202	" "
L203	" "

Circuit Ref.	Value	Description	
L204		H.F. Choke	
L205		" "	
L206		" "	
L207		H.T. Smoothing Choke	
L208		L.T. " "	
S1		Lever Switch	
S2A	}	Switch Wafer for	
S2B			Aerial coils
S2C			Switch Wafer for
S2D			R.f. coils
S2E			Switch Wafer for
S2F			Oscillator coils
S3		4-pole 3-position switch	
S201		Switch 4 position 2 pole × 3 Wafers	
VB201		Vibrator Separate Drive (Non Synch.)	
LS1		Loudspeaker	
FS1A	3A	Fuse	
FS1D	250mA	"	
FS1C	500mA	"	
FS1B	1.5A	"	
LP1		Lamp	
LP2		"	

Supplied with the receiver are the following ancillary items:—

Quantity	Description	Code No.
2	Small Earth Pin	YA 1152
2	Receiver Headgear	Y1/ZA.28659
41 yds	Aerial Wire R4 Mk1	Y3/WB 1057
20 ft	Earth Wire R5 Mk1	Y3/WB 1059
4	Aerial Insulators	ZA.4589
2	Signal Satchel No. 1	ZA.27294
1	A.C. Mains Cable	N30 E80
1	D.C. Cable	N30 E91

Quantity	Description	Code No.
1	Equipment Manual	N60 F23
1	Spare Fuse Box containing:—	ZA.27395
1	Desiccator	ZA.29959
1	Metal Container for Desiccator	Z.590111
3	Fuse Link, 3A	N30Z303
3	Fuse Link, 1½A	Z.590108
3	Fuse Link, ½A	Z.590107
2	Fuse Link, ¼A	Z.590101
3	Fuse Carrier	

} ZA.39416