

HEATHKIT GRID DIP METER MODEL GD-1A



Specifications

Frequency Range	2 to 250 Mc using five coils
Dimensions	Length 7", Width $2\frac{1}{2}$ ", Depth $3\frac{1}{4}$ "
Meter Movement	500 Microampere
Power Supply	117 Volt, 50-60 Cycle 5 Watts, Transformer Operated

ASSEMBLY AND USE OF THE HEATHKIT MODEL GD-1A GRID DIP METER

The Heathkit Grid Dip Meter is a very versatile piece of test equipment. It is capable of performing many of the various tests required in the design, adjustment, and operation of high frequency radio and television equipment. Being basically a variable high frequency oscillator, it can be used as a signal generator or marker generator. As it is also a grid dip meter, it can be used to determine the resonant frequency of tuned circuits or the resonant frequency of individual parts such as coils or condensers. Because it will indicate the resonant frequency of a circuit, methods are outlined for using this information to determine unknown values of inductance, capacity or Q. When used as a diode detector, it easily checks the frequency of other high frequency RF sources. Switched to an oscillating detector and used in conjunction with a pair of headphones, it is an even more sensitive instrument for checking the frequency of other oscillators.

To begin construction turn to the section entitled "Step by Step Construction" in the back of the manual.

OPERATION OF THE GRID DIP METER

A good understanding of the operation of the Grid Dip Meter will aid materially in the proper utilization of the instrument. The Grid Dip Meter is a high frequency oscillator operating in the range from 2 to 250 MC. A microammeter is inserted in the grid circuit of the oscillator tube. Whenever the oscillator is coupled to a load, a noticeable reduction in grid current takes place. This reduction in current is termed the Grid Dip.

The most common load which will absorb energy from the oscillator is a resonant circuit tuned to the same frequency as the oscillator. The Grid Dip Meter can be changed to a wave meter by setting the bottom switch to the "Diode" position. When used as a wave meter the tube acts as a diode detector. As the instrument is tuned to the frequency of a nearby RF source, the diode current reading on the meter will increase. (The sensitivity control must be advanced to maximum initially). Thus, the GD-1A can be used to determine the frequency of other oscillating circuits.

Plugging a pair of headphones into the phone jack and setting the bottom switch to the oscillator position converts the GD-1A to an oscillating detector. This arrangement can also be used to determine the frequency of other oscillating circuits. As the GD-1A is tuned to the frequency of another nearby RF source, a whistle or beat note is heard in the phones. When the GD-1A is adjusted to the lowest beat note (zero-beat), the frequency read on the meter scale is the same as the frequency of the other oscillating circuit. (At high frequencies only a click will be heard.)

USING THE GRID DIP METER

Basic in the use of the Grid Dip Meter is the coupling of the instrument to the test circuit. It is possible to couple to the test circuit either inductively or capacitively. Inductive coupling is usually the most convenient. Capacity coupling is necessary in some instances such as in the case of co-axial lines where shielding complicates the situation. For the most accurate reading, the coupling between the Grid Dip Meter and test circuit should be as loose as possible (wide spacing between units) while yet being able to obtain a readable dip.

The relative Q of a circuit can be quickly determined by noting the sharpness of the dip. A broad dip is indicative of a low Q circuit.

Assembling a few different resonant circuits and determining their resonant frequency will familiarize the builder with the operation of the Grid Dip Meter.

It will be found that as the dial is rotated from one end of a band to the other that the meter reading also changes. If the sensitivity control is set for a mid-scale meter reading when the dial is at about the middle of the band, the adjustment will probably be sufficient for any frequency setting within the band.

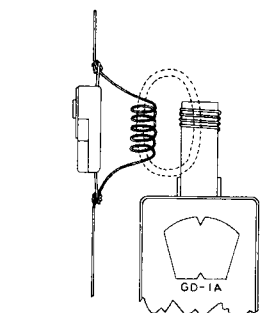

Inductive coupling to a coil.

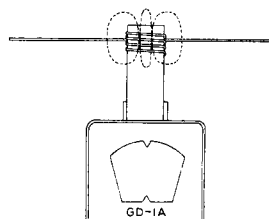

Inductive coupling to a straight wire.

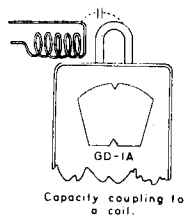

Capacity coupling to a coil.

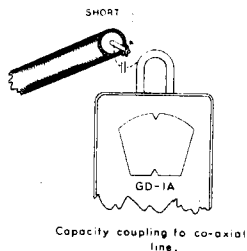

Capacity coupling to co-axial line.

DETERMINING AN UNKNOWN CAPACITY

Unknown values of capacity between seventy and two thousand MMF can readily be measured with the Grid Dip Meter. The unknown condenser should be placed in parallel with coil "C" of the coil set thus forming a parallel resonant circuit.

Depending on the suspected value of the unknown condenser (see graph) coil A or B should be plugged into the instrument. Set the Diode Oscillator switch to Osc. position. Couple quite closely to the coil of the parallel resonant circuit containing the unknown condenser and tune the GD-1A through the frequency range. When the dip has been detected, it may be helpful to reduce the coupling in order that the dip shows up over a very narrow frequency band. At maximum dip, read the frequency indicated on the dial, and from the graph, read the value of the unknown condenser. A glance at the graph will reveal that condensers under sixty-five MMF are not covered. To determine values in this range, an extra capacitor of about 100 MMF should be used. If it is not a precision capacitor, its value can be determined by the method outlined above. Once its value is known, it should be connected in parallel with the unknown condenser and coil C. Using this method, the total capacity of this test circuit is determined. The value of the unknown condenser is the difference between the total capacity in the test circuit and the value of the known added condenser.

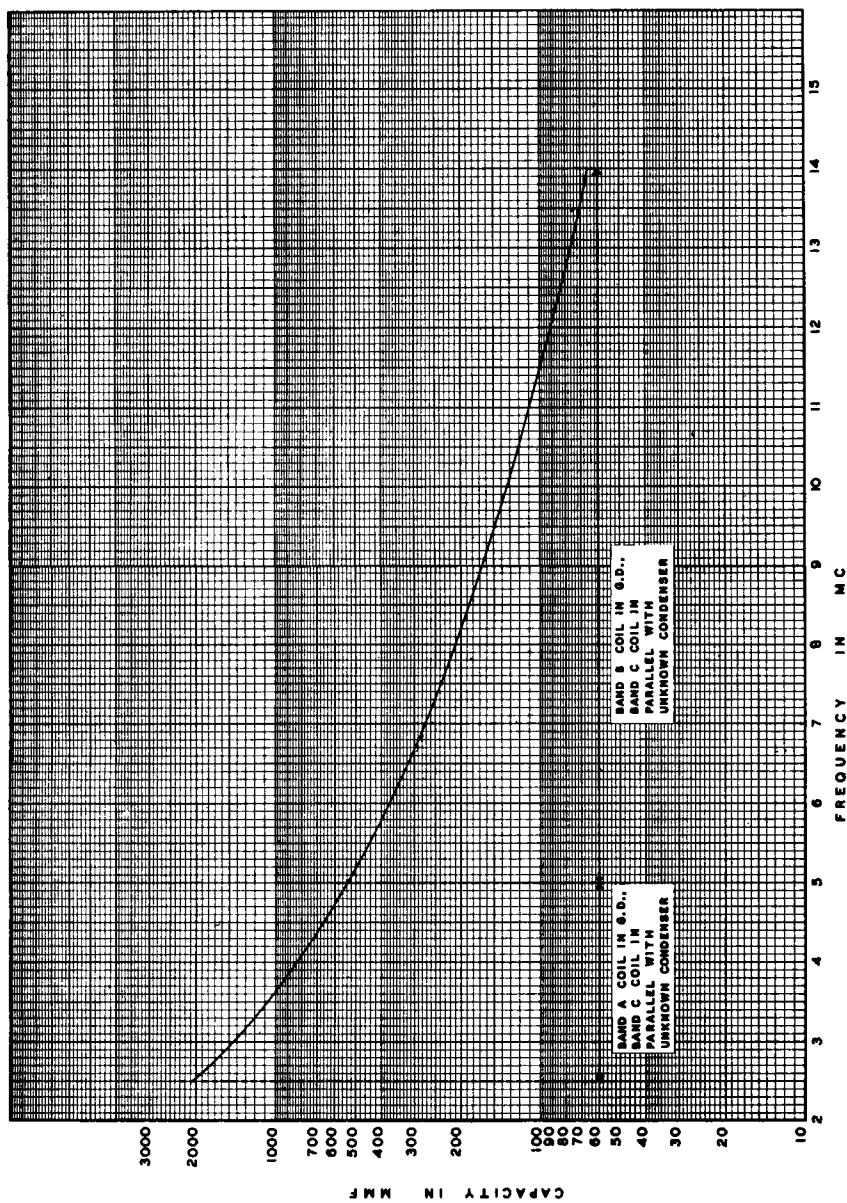

When measuring an unknown capacity, certain errors must be considered. Among these are capacity in the coil, capacity caused by nearby metallic objects, and shift of resonant frequency by inductance within the capacitor. For most applications these may be neglected.

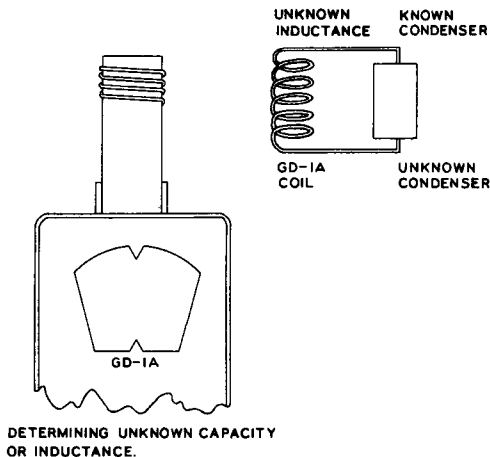

MEASURING INDUCTANCE OF RF COILS

Unknown inductances can be readily determined by using the Grid Dip Meter and some known capacitor. The capacitor should be a small, low tolerance unit such as a silver mica of about 100MMF. (The capacity of some unknown condenser may be determined as outlined above and used in this test.) Connect the capacitor across the inductor forming a parallel resonant circuit. Loosely couple the Grid Dip Meter to this circuit and determine its resonant frequency. Using the value of the capacitor and the resonant frequency, the inductance of the coil can be computed as follows:

$$Lx = \frac{1}{39.48f^2C}$$

The inductance can also be found by referring to a reactance chart such as is found in many radio handbooks. As when measuring capacities, certain errors (usually negligible) effect the results.

DETERMINING THE Q OF A TUNED CIRCUIT

The Q of a tuned circuit may be measured using the Grid Dip Meter and a Vacuum Tube Voltmeter. Connect the VTVM across the tuned circuit. Loosely couple the Grid Dip Meter to the tuned circuit and adjust the output frequency until a maximum reading on the VTVM is obtained. Slightly adjusting the coupling will permit setting the VTVM reading to a convenient value. (Once set do not change the coupling.) Note the frequency of the Grid Dip Meter, (f_c). Retune the Grid Dip Meter until the VTVM reads 70.7% of the peak value. Note this frequency (f_1) and detune the Grid Dip Meter in the other direction until the VTVM again reads 70.7% of peak value. Note this frequency (f_2). The Q of the circuit is then calculated as follows:

$$Q = \frac{f_c}{\Delta f} \quad \text{Where } \Delta f \text{ equals the difference between } f_1 \text{ and } f_2.$$

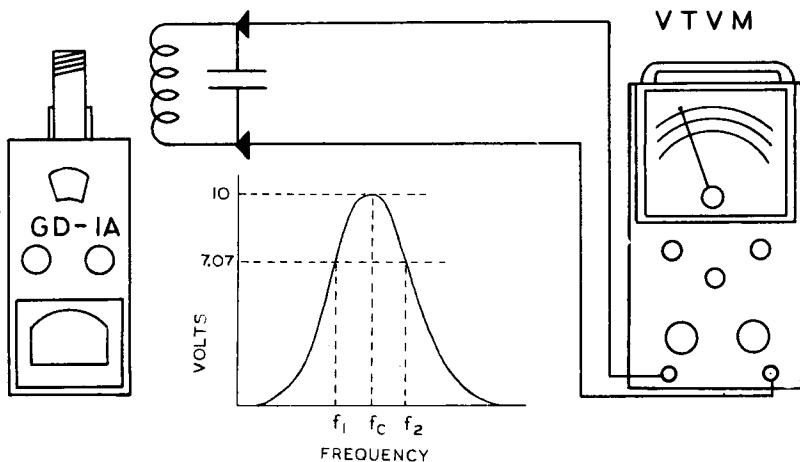

Measuring "Q" of a tuned circuit.

CAUTION: BE VERY CAREFUL WHEN USING THE GRID DIP METER NEAR HIGH VOLTAGE CIRCUITS. IT IS POSSIBLE FOR THE OPERATOR TO RECEIVE A SEVERE OR DEADLY SHOCK IF THE METER OR COIL SHOULD TOUCH A HIGH VOLTAGE CIRCUIT.

PRETUNING A TRANSMITTER

The GD-1A provides an excellent means of preadjusting a transmitter prior to applying voltage. Each of the various tuning circuits throughout the transmitter can be set to its approximate operating frequency. Thus, when the power is applied, only a slight adjustment is needed to finish the job.

NEUTRALIZATION

The grid dip meter is very useful when neutralizing a transmitter. Set the bottom switch to the "Diode" position so that the instrument can be used as a tuned detector. Remove the plate voltage (filament should be on) from the stage of the transmitter to be neutralized, and apply power to the driver stage.

Using the GD-1A as a detector, couple its coil to the output of the stage being adjusted. Adjust the GD-1A for maximum meter indication and then adjust the neutralizing control for a minimum meter reading. It will probably be necessary to readjust the output circuit to proper frequency and then repeat the neutralizing adjustment. As the neutralization is being accomplished, it may be necessary to couple the GD-1A more closely to the output circuit.

Another method is to couple the grid dip meter to the input of the stage to be neutralized and adjust to the maximum dip. (All plate voltages in the transmitter should be turned off). Set the neutralizing control so that no deflection of the GD-1A meter is seen when the output circuit of the stage is rotated through the operating frequency.

LOCATING PARASITIC OSCILLATIONS

Parasitic oscillations are easily located by applying power to the transmitter and checking the various stages for oscillations other than those intended. (Use the Grid Dip Meter as an oscillating detector.) Once the frequency of the parasitic oscillation is known, the power to the transmitter may be turned off and the unwanted resonant circuits located. (Using the GD-1A as a grid dip meter, check circuit wiring, chokes, etc. for unwanted resonant frequencies).

ANTENNA ADJUSTMENTS

The Grid Dip Meter provides a means of adjusting antennas without creating interference. Loose coupling is usually sufficient although the proper type should be used, that is, capacity coupling to a voltage maximum point or inductive coupling to a current maximum.

When the GD-1A is coupled to the end of an antenna, a slight change takes place in its "effective" length. This change may be up to approximately 3% with the resonant frequency appearing lower than is actually the case. There is no change when the meter is coupled to the middle part of the antenna. Proper matching of open wire lines to the antenna can be determined by using the GD-1A in the diode position as a detector of the standing waves present on the line. Arrange to hold the coupling of the GD-1A to the line constant (by holding a small piece of insulator between the coil and the line for example,) and move the meter along the line. If the meter indication varies considerably, standing waves are present. When the line is properly matched, no standing waves can be detected. Power must be fed to the feed lines by the transmitter or other RF source.

The check for proper matching of a co-axial line is noting the amount of power delivered to the antenna. The GD-1A is used as a field strength meter (set in diode position and placed near the antenna where the change in output can be noted.) Proper matching is denoted by maximum output from the antenna.

STEP BY STEP CONSTRUCTION

Begin by checking the parts against the parts list. In this way, you will become familiar with the various parts and also you will avoid throwing away any small parts with the packing.

Should inspection reveal the necessity for replacement of a component, write to the Heath Company immediately. The following information should be supplied in all cases:

- (A) Clearly identify the part in question by using the part number and description found in the manual parts list.
- (B) Identify the type and model number of kit in which it is used.
- (C) Mention the order number and date of kit purchase.
- (D) Describe the nature of defect or reason for requesting replacement.

The Heath Company will promptly supply the necessary replacement. Please do not return the defective component until specifically requested to do so. Do not under any circumstances dismantle the component in question as this will void the guarantee. If tubes are to be replaced, please pack them carefully to prevent breakage in shipment as broken tubes are not eligible for replacement.

After the parts have been identified, actual assembly can be started.

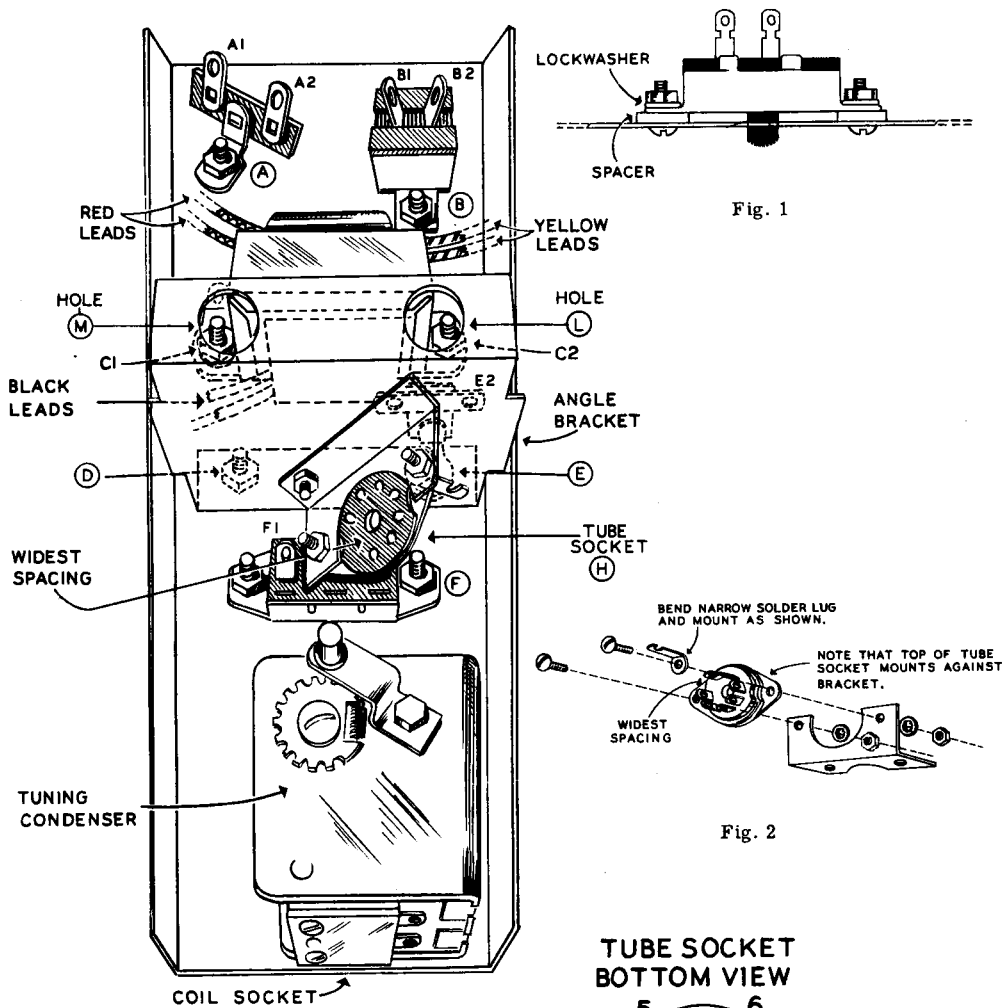

Fig. 1

PICTORIAL 1
MOUNTING OF PARTS ON
BOTTOM PLATE

TUBE SOCKET
BOTTOM VIEW

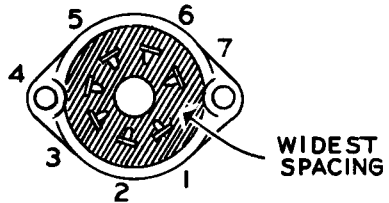

Fig. 3

STEP BY STEP ASSEMBLY

Mounting of parts on bottom plate. (Observe Pictorial 1).

- () Mount a two-lug terminal strip in location A with a 6-32 screw, lockwasher, and nut.
- () Mount the rectifier in location B with a 6-32 screw, lockwasher, and nut. Be sure that the rectifier is positioned exactly as shown in the pictorial.
(Note the color coding of the power transformer leads. The transformer should be mounted so that the red leads are nearest location A. Be sure the transformer is not mounted backwards.)
- () Place a lockwasher over a 6-32 screw, slide the screw through the hole in location C1, slip the transformer mounting flange over the screw, slide on a solder lug, and fasten with a nut.
- () Place a lockwasher over a 6-32 screw, slide the screw through the hole in location C2, pass the screw through the transformer mounting flange, slide on a lockwasher, and fasten with a nut.
- () In location D, fasten the angle bracket to the chassis by means of a 6-32 screw, lockwasher and nut.
- () In location E, slide a 6-32 screw through the hole in the bottom plate, pass it through the hole in the angle bracket, slide a one-lug terminal strip over the screw, and fasten with a lockwasher and nut.
- () In location M, temporarily mount the sensitivity control (with off-on switch on back) on the angle bracket. Use a control nut. See Pictorial 3 for the proper placement of the lugs.
- () Mount the DIODE-OSC. switch in location F by means of two 6-32 screws, fiber washers, lockwashers, and nuts. Figure 1 shows how the washers are mounted between the bottom plate and the switch frame. Be sure the switch mounting is not reversed. Pictorial 2 clearly shows the mounting of this switch.
- () Mount the small solder lug and the tube socket on the tube mounting bracket by means of 3-48 screws, lockwashers, and nuts. See Figure 2 and Figure 7. Make certain that the widest spacing between pin holes (see Figure 3) is as shown in Pictorial 1.
- () Bend the small solder lug as shown in Figure 2 and Figure 7.
- () Fasten the tube mounting bracket to the angle bracket by means of 6-32 screws, lockwashers, and nuts.

Tuning Condenser Sub-assembly

CAUTION: FULLY MESH THE PLATES OF THE VARIABLE TUNING CONDENSER—KEEP THEM MESHED WHILE ASSEMBLING THE INSTRUMENT. THIS WILL PREVENT DAMAGING THEM DURING CONSTRUCTION.

Note that there are two sets of stator terminal lugs on the tuning condenser. Two of these are cut off and two are left on—therefore, in the step which follows, make sure that the correct lugs are cut off.

- () Study Figure 4 and cut off the two stator lugs indicated. These lugs (shown dotted) are nearest the small brackets which are riveted on the condenser frame.
- () Mount the coil socket on the tuning condenser frame as shown in Figure 4. Use 6-32 flat head screws.
- () Solder each coil socket lug to the nearby stator contact indicated in Figure 4.
- () Mount a solder lug on the tuning condenser frame as shown in Figure 4. Use a short screw.

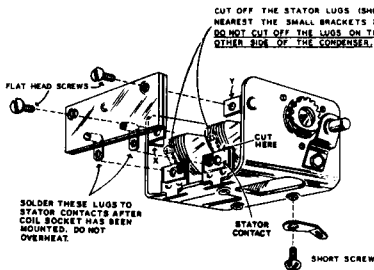

Fig. 4

BEND BACK STATOR TERMINAL LUGS
AS SHOWN HERE. MOUNT EACH DISC
CONDENSER WITH A 3-48 SCREW AND NUT.

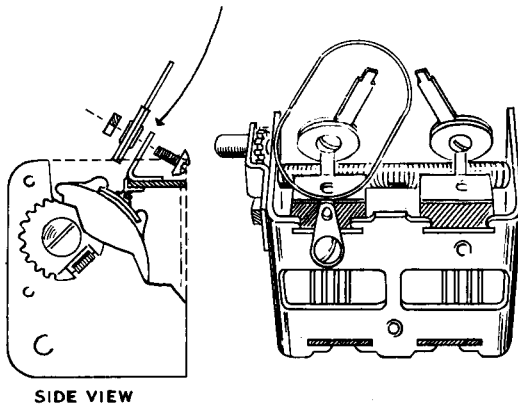
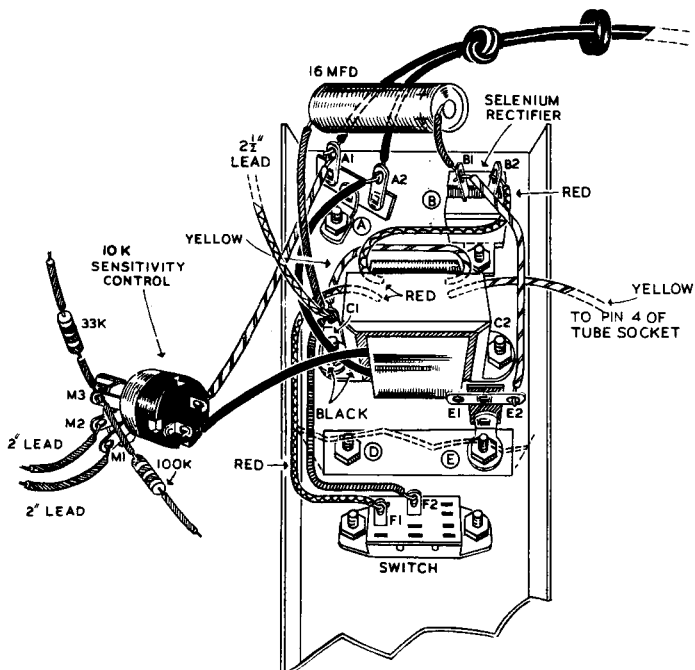

Fig. 5



PICTORIAL 2

- () Bend the remaining stator lugs as shown in Figure 5 (side view). Mount a disc condenser on each of these lugs with a 3-48 screw and nut. Note the angle of the disc condenser leads.
- () Mount the tuning condenser on the bottom plate with three short screws. Use a #6 lock-washer between screw head and bottom plate on each of these three screws.

Pictorial 2 Wiring

Note: All guarantees are voided and we will not repair or service instruments in which acid core solder or paste fluxes have been used. When in doubt about solder, it is recommended that a new roll be purchased which is plainly marked "Rosin Core Radio Solder."

It is helpful to place the large pictorial diagrams on the wall above your work space so that they may be referred to readily.

Read the notes on the inside rear cover concerning wiring and soldering before you start wiring your kit.

In some cases, more than one connection is made to the same terminal. This condition is designated by the abbreviation (NS), meaning that the connection should not be soldered until other leads have been connected. Wherever only one lead is connected to a terminal or where the last lead has been connected, the joint should be soldered. This is indicated by the abbreviation (S).

Unless otherwise indicated, all wire used is insulated.

The leads on components such as transformers, resistors and condensers are frequently longer than necessary. When wiring these parts into the circuit, the leads should be cut to the proper length. This will result in not only a neater looking instrument, but in many instances, proper operation is impossible with long untrimmed leads in critical parts of the circuit.

- () Connect one black lead of the power transformer to A2 (NS).
- () Connect the other black lead to one lug (either lug) of the OFF-ON switch on the back of the sensitivity control (S).
- () Connect one red lead of the power transformer to F1 (S). Run this lead along the edge of the bottom plate.
- () Connect the other red lead to B2 (S).
- () Connect one yellow lead of the power transformer to pin 4 of the tube socket (S). (See Pictorial 3). (When soldering to miniature tube socket terminals, use care to prevent the solder from flowing into the socket pin holes. This could prevent insertion of the tube pin and possibly cause damage to the tube).
- () Connect the other yellow lead to solder lug C1 (NS).
- () Run a lead from C1 (NS) to F2 (S). Run this lead along the edge of the bottom plate.
- () Run a wire from A1 (NS) to that lug on the OFF-ON switch (on the back of the sensitivity control) which does not have a black transformer lead connected to it (S).
- () Slide a rubber grommet over the line cord.
- () Split and knot the line cord as shown, and connect one lead of the cord to A2 (S). The knot provides strain relief should the cord be accidentally jerked.
- () Connect the other lead of the line cord to A1 (S).
- () Run a lead from B1 (NS) to E2 (NS).
- () Connect the POSITIVE lead (marked +++ or "POSITIVE") of the 16 mfd. condenser to B1 (S).
- () The other lead of the 16 mfd. condenser connects to solder lug C1 (NS).
- () Connect a 2½" length of wire to solder lug C1 (S). Leave the other end free.
- () Remove the sensitivity control from the angle bracket. Leave the wires to the OFF-ON switch connected.

To facilitate wiring, several connections are made to this control while it is unmounted.

- () Cut one lead of a 100K resistor (brown-black-yellow) to 1" in length. Slip spaghetti over this lead, and connect it to M3 (NS). Leave the other end free.
- () Cut one lead of a 33K resistor (orange-orange-orange) to 1" in length. Slip spaghetti over this lead, and connect it to M3 (S). Leave the other end free.
- () Strip both ends of a 2" length of wire. Connect one end of this lead to M2 (S). Leave the other end free.
- () Strip both ends of a 2" length of wire. Connect one end of this lead to M1 (S). Leave the other end free.

This completes the wiring shown in Pictorial 2.

Disc Condenser Connections

IMPORTANT: The connections described below are extremely critical, since they have a direct bearing on the calibration accuracy of the instrument.

- () Observing Figures 6 and 7, loosen the nut holding the disc condenser on the stator lug nearest the slide switch so that the condenser is just loose enough to be rotated.
- () Cut off the small tongue at the end of the disc condenser lead.
- () Now rotate the disc condenser and, at the same time, bend the stator lug so that the end of the condenser lead touches pin 1 of socket H as near as possible to the body of the socket.
- () Bend pin 1 down against the condenser lead and solder the connection.
- () Check to see that there is sufficient clearance between the connection just made and the socket frame, to avoid the possibility of a short.
- () Now flow solder over the screw head, the stator lug, and the disc condenser plate, as shown in Figure 7.
- () In a like manner, connect the lead of the other disc condenser to pin 2 of socket H (S).

**CUT OFF THIS SMALL TONGUE
AT THE END OF THE CONDENSER
LEAD.**

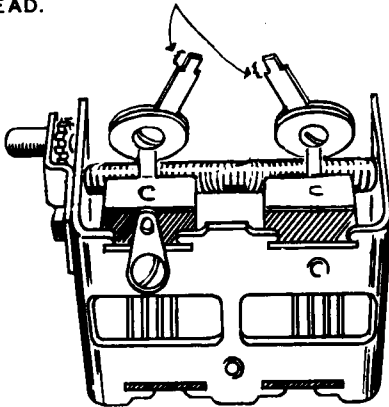

Fig. 6

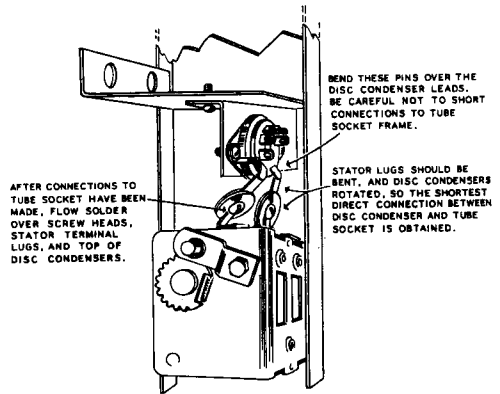

Fig. 7

Preparation of Tuning Drum (See Figure 8)

- () Assemble the frequency dial scale and the tuning drum so that the calibration markings are visible through the face of the drum. Fasten the dial scale to the drum with four pieces of adhesive-backed material from the label set. The adhesive strips should cover a portion of the drum rim and the paper scale. Blank extra dial plates have been printed on the fold-in drawings. These are for the builder who wishes to calibrate the instrument himself. Details are given under "Calibration."
- () Start a 6-32 set screw in the hub of the tuning drum. Place the drum on the tuning condenser shaft and tighten the set screw just enough to hold the drum on the shaft. See Figure 9.

Note Pictorial 3.

- () Place the front panel against the angle bracket and line up the holes for the phone jack and sensitivity control.
- () Mount the sensitivity control in location M. See Figure 10 for details of hardware assembly. Keep the lugs exactly as indicated in Pictorial 3. On some controls, a small locating lug protrudes from the front of the control housing. If this lug interferes with the mounting, cut it off or bend it over.
- () Mount the phone jack (see Figure 10 and Pictorial 3) in location L. Keep the lugs oriented exactly as indicated.

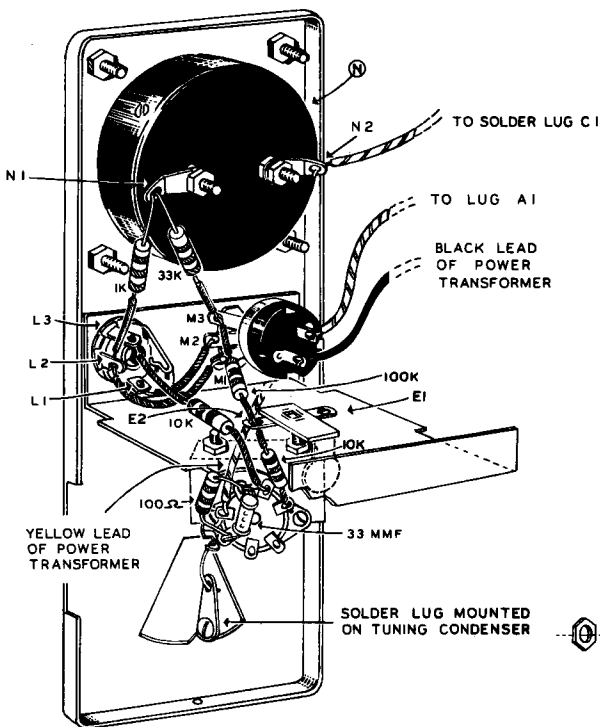

PICTORIAL 3

TAPE OVER DRUM RIM AND BACK OF FREQUENCY DIAL SCALE

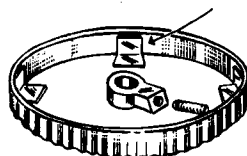

Fig. 8

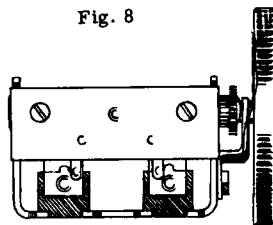

Fig. 9

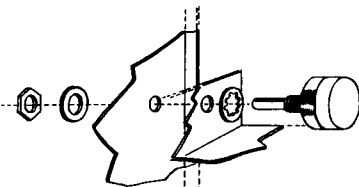

Fig. 10

- () The free end of the 2" lead on M2 is now connected to L1 (S).
- () The free end of the 2" lead on M1 is now connected to L2(NS).
- () On the back of the meter case, loosen the terminal nuts and orient the lugs as shown in Pictorial 3. Retighten the nuts.
- () Mount the meter in location N with the hardware supplied with the meter. The picture of the instrument on Page 1 of this manual shows the proper positioning of the meter. Be sure the meter is not mounted upside down.
- () The free lead of the 33K resistor (orange-orange-orange), which has one lead connected to M3, should be connected to meter lug N1 (NS). (Use spaghetti). Be sure the lead cannot short to the transformer frame.
- () The free lead of the 100K resistor (brown-black-yellow), which has one lead connected to M3, should be connected to E2 (NS).
- () Check to see that there is no possibility of lug M3 shorting to the sensitivity control housing.
- () Connect a 10K resistor (brown-black-orange) between L3 (S) and pin 6 of socket H (S). (Use spaghetti).
- () Connect a 10K resistor (brown-black-orange) between E2 (S) and pin 7 of socket H (S). (Use spaghetti).
- () Connect a 1K resistor (brown-black-red) between L2 (S) and meter lug N1 (S).
- () Connect a 100 ohm resistor (brown-black-brown) between pin 5 of socket H (NS) and pin 3 of socket H (NS).
- () Pass one lead of the 33 MMF condenser through pin 3 of socket H (S), make a wrap around connection at the indented portion of the nearby narrow solder lug (S) and continue the lead to the solder lug on the tuning condenser frame. The solder lug mounted on the tuning condenser should now be bent flat so that it will not interfere with slipping the assembly into cabinet.
- () Connect the other lead of the 33 MMF condenser to pin 5 of socket H (S).
- () Connect the free end of the length of wire on C1 to meter terminal N2 (S).

IMPORTANT WARNING

A miniature tube can be easily damaged when plugging it into its socket. Therefore, use extreme care when installing the 6AF4. WE DO NOT GUARANTEE OR REPLACE MINIATURE TUBES BROKEN DURING INSTALLATION.

- () Insert the 6AF4 tube in socket H.
 - () Fasten the knob on the sensitivity control by tightening the set screw.
- The instrument is now ready to calibrate—see instructions below. Once the calibration is completed, the final steps of assembly should be performed. These are as follows:

- () Install the four rubber feet in the bottom panel. Figure 11 shows the detail.
- () Pass the line cord through the cabinet so that it comes out the back. The back of the cabinet has a large U notch in one end.
- () Fit the front panel to the cabinet by sliding the flanges inside the panel rim. Make sure that the dimple in the end of the panel rim mates with the hole in the cabinet flange.
- () Be certain that the knot in the line cord is completely inside the cabinet. The grommet which is on the line cord should then be slipped into the large U notch.
- () Complete the assembly by adding the back panel to the cabinet and secure it with two #6 sheet metal screws.
- () Check the clearances between the tuning drum and the cabinet. See that drum operates without binding or rubbing. If necessary, adjust the position of the drum on the tuning condenser shaft. Be careful not to disturb the calibration during this adjustment.

This completes the construction of the instrument.



Fig. 11

SPECIAL NOTE: When the instrument is first turned on (set to Osc. position), the meter will indicate below zero. Upon warming up, the meter will read correctly. This fact is mentioned because the builder might conclude that the meter is connected backwards when he first turns on the instrument and sees the meter reading below zero.

ACCURACY

It should be remembered that the grid dip meter is neither designed nor intended to be used for applications requiring a high degree of accuracy. The grid dip meter is not in the same class as accurate signal generators many of which can be used as secondary frequency standards. Calibration errors up to 5% can be expected. However, except for the specialized uses involving high accuracy, this instrument is invaluable in applications such as outlined in the manual as well as others too numerous to mention.

One factor concerning the accuracy of the highest band (100-250 MC) must be considered. At high frequencies such as these, the actual wiring of the kit comes into the picture. Such things as proper placement of components, correct lead dress, short lead lengths, good solder connections etc. all are important. The manual shows how the kit should be constructed for best results, but the actual mechanics of construction are beyond the control of the Heath Company. Therefore, if the high band accuracy seems greatly different from that of the other bands, check the actual construction of the kit for proper wiring and parts location as outlined in the pictorial and step-by-step instructions.

CALIBRATION

The Grid Dip Meter is provided with a ready-calibrated dial. This dial will be sufficiently accurate for most applications. If no means of checking frequency is available, the dial may be set so that the calibration end markings coincide with the pointers (on the panel) when the tuning condenser is completely meshed.

A more accurate adjustment of the ready-calibrated dial is possible if a short wave receiver or high frequency signal generator is available.

USING A RECEIVER: If the frequency settings on the receiver are known to be accurate, it is only necessary to tune in the Grid Dip Meter (set to OSC position) on the receiver and set the GD-1A dial to the same frequency reading as the receiver dial.

If the dial calibrations on the receiver are not accurate, tune the receiver to some station whose frequency is known (WWV for example) and then tune the Grid Dip Meter to this same frequency (set in OSC position). Adjust the tuning dial on the GD-1A to read this same frequency.

USING A HIGH FREQUENCY SIGNAL GENERATOR: A signal generator offers the easiest means of setting the ready-calibrated dial on the Grid Dip Meter. Set the signal generator to some easily read frequency on the Grid Dip dial. Using the GD-1A as a diode detector (Diode position), adjust for maximum deflection of the meter. Tighten the tuning dial set screw so that the GD-1A indicates the same frequency as the signal generator.

COMPLETE CALIBRATION OF THE GD-1A

Extra dial plates have been prepared for the builder who has the equipment available to completely calibrate his own instrument. In doing so, differences in wiring technique and positioning which will shift frequency settings slightly can be corrected. The blank dial plate may be temporarily fastened to the outside of the tuning drum while making the calibration marks. After the calibration is completed the dial plate should be fastened under the tuning dial for protection. If the GD-1A is calibrated with a receiver (the receiver should be accurately calibrated), first set the receiver to the frequency and then adjust the GD-1A (used as an oscillator) to the same frequency and mark the dial. Repeat this procedure for each frequency mark desired.

If the GD-1A is calibrated with a signal generator, first set the signal generator to the frequency and then adjust the GD-1A (used as a diode detector) to the same frequency, and then mark the dial. Repeat for each frequency point.

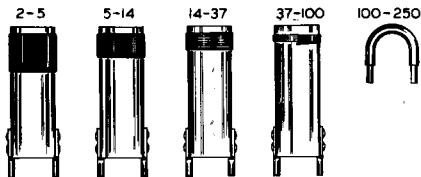

IDENTIFYING CHARACTERISTICS OF COILS

IN CASE OF DIFFICULTY

1. Recheck the wiring very carefully. Tracing the leads on the pictorial wiring diagram in colored pencil as they are checked in the instrument will prevent overlooking some connections.
2. Compare tube socket voltages with those shown on the schematic diagram. Readings given were made using a vacuum tube voltmeter. Other type meters will give lower readings.
3. Test tube to be certain it is operating properly.
4. Write to the Heath Company describing operating characteristics and listing the voltages measured at the various tube socket connections. (See Service Information).

SERVICE

In event continued operational difficulties of the completed instrument are experienced, may we remind you that the facilities of the Heath Company Service Department are at your disposal. Your instrument may be returned for inspection and repair for a service charge of \$3.00 plus the cost of any additional material that may be required. **THIS SERVICE POLICY APPLIES ONLY TO COMPLETED INSTRUMENTS CONSTRUCTED IN ACCORDANCE WITH THE INSTRUCTIONS AS STATED IN THE MANUAL.** Instruments that are not completed or instruments that are modified will not be accepted for repair. Instruments showing evidence of acid core solder or paste fluxes will be returned not repaired. This factory repair service is available for a period of one year from the date of purchase.

NOTE: Before returning this unit be sure all parts are securely mounted. Attach a tag to the instrument giving name, address and trouble experienced. Pack in a rugged container, preferably wood, using at least three inches of shredded newspaper or excelsior on all sides. Do not ship in the original kit carton as this carton is not considered adequate for safe shipment of the completed instrument. Ship by prepaid express if possible. Return shipment will be made by express collect. Note that a carrier cannot be held liable for damages in transit if packing, **IN HIS OPINION**, is insufficient.

Prices are subject to change without notice. The Heath Company reserves the right to change the design of this instrument without incurring liability for equipment previously supplied.

WARRANTY

The Heath Company limits its warranty on any parts supplied with any Heathkit (except tubes, meters, and rectifiers, where the original manufacturer's guarantee only applies) to the replacement within three (3) months of said part which, when returned with prior permission, postpaid, was, in the judgment of the Heath Company, defective at the time of sale.

The assembler is urged to follow the instructions exactly as provided. The Heath Company assumes no responsibility nor liability for any damages or injuries sustained in the assembly of the device or in the operation of the completed instrument.

HEATH COMPANY
Benton Harbor, Michigan

PARTS LIST

When ordering replacement parts, be sure to specify part number shown below.

Part No.	Quan.	Description	Part No.	Quan.	Description
1-3	1	100 ohm Comp. Resistor	250-2	4	3-48 x 1/4" Screws
1-9	1	1K " " "	250-7	4	6-32 x 3/16" Screws
1-20	2	10K " " "	250-8	2	#6 Sheet-metal Screws
1-24	1	33K " " "	250-9	10	6-32 x 3/8" Screws
1-26	1	100K " " "	250-28	1	6-32 x 1/4" Set Screw
19-15	1	10K " Sensitivity Control with switch	250-32	2	6-32 x 3/8" Screws, flat head
			252-1	4	3-48 Nuts
20-25	2	90 mmf. Disc Condensers	252-3	10	6-32 Nuts
21-7	1	33 mmf. Ceramic Condenser	252-7	2	Control Nuts
25-5	1	16 mfd. Electrolytic "	253-1	2	Fiber Washers
26-10	1	Variable Condenser	253-10	2	Control Washers
40-24A	1	2-5 mc Coil	254-1	14	#6 Lockwashers
40-24B	1	5-14 mc Coil	254-4	2	Control Lockwashers
40-24C	1	14-37 mc Coil	254-7	2	#3 Lockwashers
40-24D	1	37-100 mc Coil	259-1	2	#6 Solder Lugs
40-M25	1	100-250 mc Coil	259-6	1	Narrow Solder Lug
54-17	1	Power Transformer	261-1	4	Rubber Feet
57-1	1	Rectifier	344-1	1	Length Hookup Wire
60-1	1	Switch	346-1	1	Length Spaghetti
73-1	1	Rubber Grommet, 3/8"	390-1	1	Label Set
89-1	1	Line Cord	407-12	1	Meter
90-15	1	Cabinet	411-44	1	6AF4 Tube
203-32F48	1	Front Panel	431-1	1	One-lug Terminal Strip
203-33	1	Back Panel	431-2	1	Two-lug Terminal Strip
204-M40	1	Tube Bracket	434-33	1	Coil Socket
204-M41	1	Angle Bracket	434-34	1	Tube Socket, miniature
205-M15	1	Bottom Plate	436-4	1	Phone Jack
			445-3	1	Calibration Scale
			462-12	1	Tuning Drum
			462-13	1	Knob

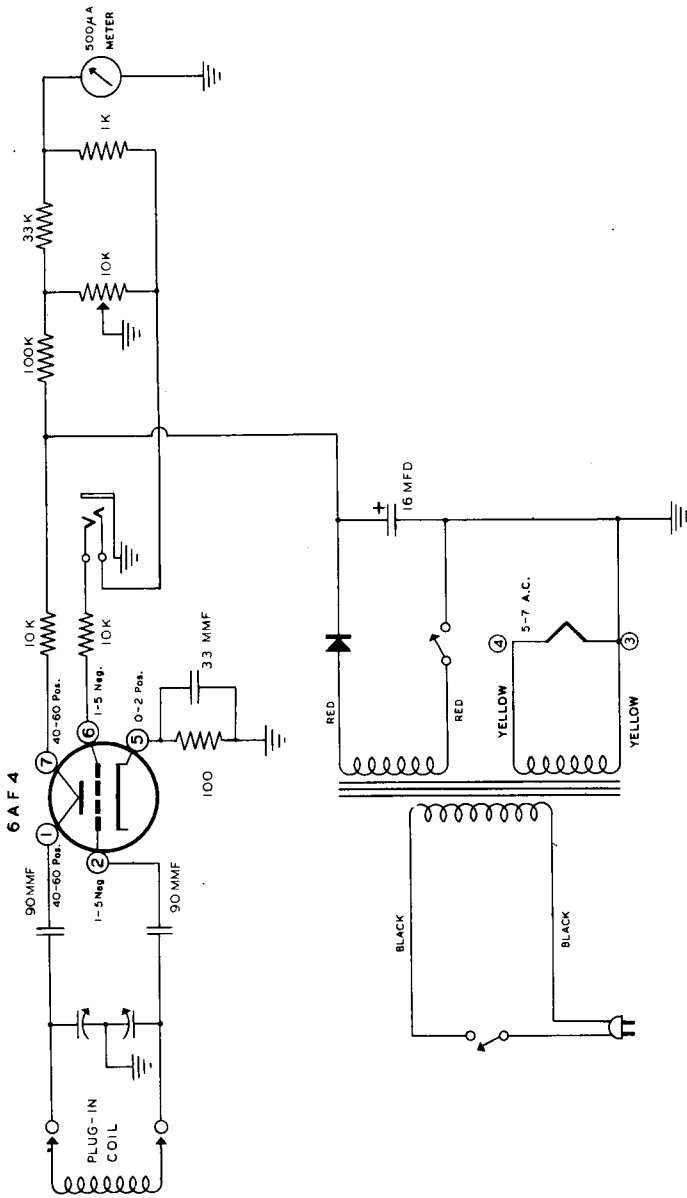

Tube socket voltages shown are D.C. unless otherwise stated.

Heathkit
 GRID DIP METER
 MODEL GD-1A

**WIRING OF EXPORT TYPE
110/220 VOLT POWER
TRANSFORMERS**

These transformers have a dual primary for use on either 110 Volts or 220 Volts.
Wire as shown.

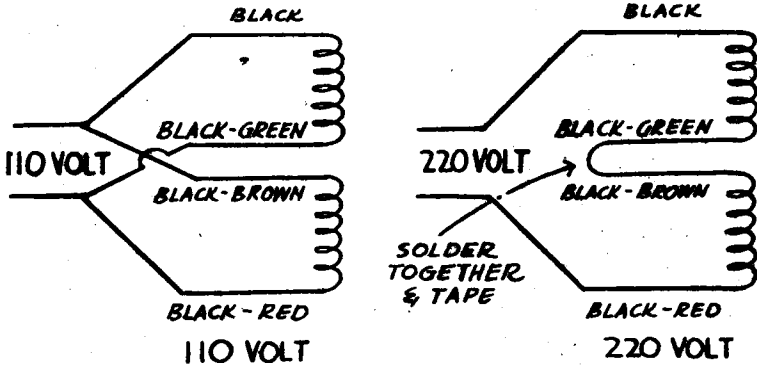

Notes

FASTEN CLIP TO CABINET BEFORE PLUGGING IN COIL.

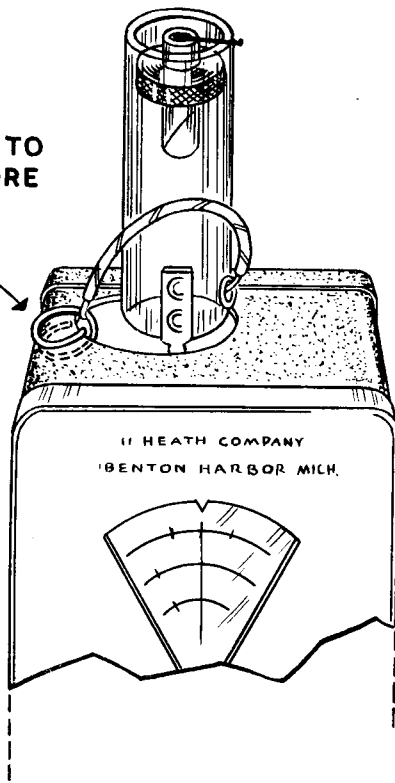

1 PIE WOUND COIL



2 PIE WOUND COIL

IDENTIFYING CHARACTERISTICS OF COILS

USE OF THE EXTENDED RANGE COILS (Kit # 341)

The two tapped coils, when used with the Grid Dip Meter, extend the range down to 350 KC. Use the correlation curves (as explained below) which apply to the particular model Grid Dip Meter you have (GD-1 or GD-1A).

Before plugging in the coils, be sure to slide the small clip over the edge of the large hole in the cabinet. See drawing.

For Model GD-1: Use the set of correlation curves for the Model GD-1. (See title of the graph). The GD-1 graph has two curves, the upper applies when the 1 pie wound coil is plugged in the instrument. The lower curve applies when the 2 pie wound coil is used.

Note that the scale markings on the outside edge of the dial scale are marked from 100 to 260. This is the scale that should be used with the correlation curves. Use of the curves can best be shown by means of example.

EXAMPLE: To set the GD-1 for 1.1 MC output:

- (a) Note that 1.1 MC is on LEFT side of graph. This means that the 1 pie wound coil should be plugged into the coil socket.
- (b) Clip tap lead on edge of hole in cabinet. Plug in the 1 pie wound coil.
- (c) Read from 1.1 MC horizontally to the right to the intersection with the UPPER curve.
- (d) Read from intersecting point (obtained in step c) vertically downward to dial setting indicated on bottom of graph. i.e., 162.
- (e) Set GD-1 dial scale to 162 and operate instrument in the same manner as when the regular coils are used.

EXAMPLE: To read from a known dial setting to an unknown frequency, the following method should be used. Suppose the 2 pie wound coil is plugged into the instrument and the dial scale reads 240. To find the frequency:

- (a) Read vertically upward from 240 to the intersection with the LOWER curve.
- (b) Read from the intersecting point (obtained in step a) horizontally RIGHT to the frequency scale and observe the frequency. In this case, it is 665 KC.

For Model GD-1A: Use the set of correlation curves for the GD-1A. (See title of the graph). The GD-1A has two curves, the upper applies when the 1 pie coil wound is plugged in the instrument. The lower curve applies when the 2 pie wound coil is used.

Note that the scale markings on the inside edge of the dial scale are marked in steps of 10 from 0 to 100. This is the scale (called the "logging" scale) that should be used with the correlation curves. Use of the curves can best be shown by means of example.

EXAMPLE: To set the GD-1A for 1.1 MC output:

- (a) Note that 1.1 MC is on the LEFT side of the graph. This means that the 1 pie wound coil should be plugged into the coil socket.
- (b) Clip tap lead on edge of hole in cabinet. Plug in the 1 pie wound coil.
- (c) Read from 1.1 MC horizontally to the right to the intersection with the UPPER curve.
- (d) Read from intersection point (obtained in step c) vertically downward to logging scale setting indicated on bottom of graph. i.e., 50.
- (e) Set GD-1A logging scale to 50 and operate instrument in the same manner as when the regular coils are used.

EXAMPLE: To read from a known dial setting to an unknown frequency, the following method should be used. Suppose the 2 pie wound coil is plugged into the instrument and the dial scale reads 70. To find the frequency:

- (a) Read vertically upward from 70 to the intersection with the LOWER curve.
- (b) Read from the intersecting point (obtained in step a) horizontally RIGHT to the frequency scale and observe the frequency. In this case it is 600 KC.

NOTE: STRIP BACKING OFF THE CORRELATION CURVE GRAPH FOR THE MODEL YOU HAVE AND STICK THE GRAPH ON THE LAST PAGE OF THE MANUAL. THROW AWAY THE GRAPH WHICH DOES NOT APPLY TO YOUR MODEL.